

Owner's Manual

Steering damper SD500 - MX & Enduro

- Technical information
- Basic adjustments
- Design features
- Safety

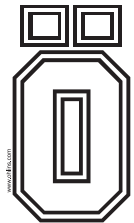
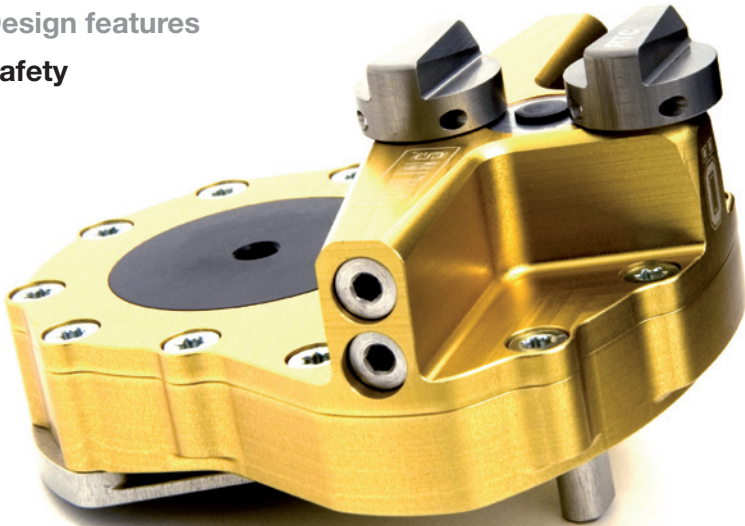

Safety precautions

Safety signals

Important information concerning safety is distinguished in this manual by following notations:



This Safety alert symbol means: Caution! Your safety is involved.

▲ WARNING!

Failure to follow warning instructions could result in severe or fatal injury to anyone working with, inspecting or using the suspension, or to bystanders.

CAUTION!

Caution indicates that special precautions must be taken to avoid damage to the suspension.

NOTE!

This indicates information that is of importance with regard to procedures.

▲ WARNING!

1. Installing a steering damper, that is not approved by the vehicle manufacturer, may affect the stability of your vehicle. Öhlins Racing AB cannot be held responsible for any personal injury or damage whatsoever that may occur after fitting the suspension. Contact an Öhlins dealer for advice.

2. Please study and make certain that you fully understand the contents in the mounting instruction(s) and the owner's manual(s) before handling this suspension kit. If you have any questions regarding installation procedures, contact an Öhlins dealer.

3. The vehicle service manual must be referred to when installing the Öhlins suspension.

CAUTION!

Make sure that the steering stops work properly. If not, it's necessary to adjust the steering stops (use washer or suchlike). If the damper is used as stop it can be damaged. Öhlins products are subject to continual improvement and development. Consequently, although these instructions include the most up-to date information available at the time of printing, there may be minor differences between your suspension and this manual. Please consult your Öhlins dealer if you have any questions with regard to the contents of the manual.

NOTE!

During storage and transportation, especially at high ambient temperature, the oil and grease used for assembling may run out inside the packing and damage the expanded polystyrene packing material. This is not unusual and is in no way detrimental to the steering damper.

Öhlins Racing AB - The Story

It was the 1970th's, a young man named Kenth Öhlin spent most of his spare time pursuing his favourite sport: motocross.

A careful observer, Kenth's attention was continually drawn to one specific detail - motocross bikes had more engine power than their suspension could handle. It was not long before Kenth realised that better performance could be achieved by improved wheel suspension.

Öhlins Racing was established in 1976, and just two years later the company won its first World Championship title. Despite being in the business for 30 years, the search for perfection and new functions is still the main focus of the company.



Congratulations

You are now the owner of an Öhlins Shock Absorber. More than one hundred World Championships and other major world titles are definitive proof that Öhlins shock absorbers offer outstanding performance and reliability.

Every product has gone through rigorous testing and engineers have spent thousands of hours, doing their very best to use every possible experience from our 30 years within the racing sport.

The product that you now have in your possession is pure racing breed that is built to withstand. By installing an Öhlins shock absorber on your vehicle you have made a clear statement... you are a serious rider with a focus on getting the maximal handling ability and outstanding feedback from your vehicle. Along comes the fact that your shock absorber will be a long lasting friend, delivering the very best of comfort and performance every time you go for a ride.

Go explore!

Introduction and Design

Introduction

The Öhlins steering damper are designed to withstand very tough treatment in conjunction with competitions. Many years of experience, and in close cooperation with World Championship teams in Motocross and Enduro, has helped us develop unique know-hows.

Before installation

Öhlins Racing AB can not be held responsible for any damage whatsoever to the steering damper or vehicle, or injury to persons if the instructions for installing and maintenance are not followed exactly. Similarly, the warranty will become null and void if the instructions are not adhered to.

NOTE!

Make sure that there is no interference between the handle bar and the top lid. It is vital that the upper bearing outer ring will be mounted correct. Check that the tower pin hole is aligned to the centre line in the frame. The damper unit must also be aligned to the bearing tower pin hole. Incorrect mounting may damage the damper unit.

NOTE!

Make certain that the steering stops are working properly. If the damper acts as a stop it can be damaged. Check that all bolts are tightened to the correct torque and that nothing fouls or restricts the handlebar when turned to each side.

Design

The Öhlins steering damper is a hydraulic damper that counteracts head shake and alleviates shock against the front wheel, which gives a safer riding.

The damper is fitted on the upper triple clamp, in the centre over the steering stem (fig.1a and fig 1b). When turning, and in the event of wobbling, shock, etc., the damper is rotated, thus forcing fluid through the valve system in the damper top-lid. Two valves are adjustable - see Settings on the next page.

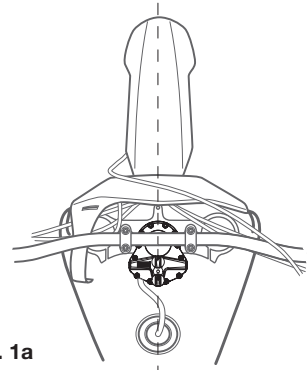

Fig. 1a

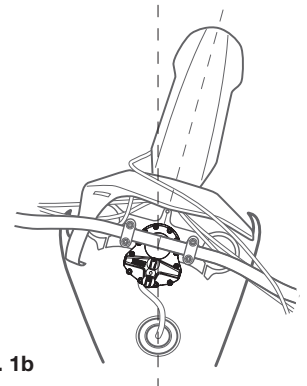

Fig. 1b

Adjustments and Set-up

Setting

The steering damper has two external adjusters (fig.2). The DL-valve (Damping Level) controls the combined low and high speed flow. The RTC-valve (Return To Centre) controls the damping back to centre position [0]. See figure 3.

The Öhlins steering damper is delivered with the adjusters set in a suggested basic position, see the recommendation below. Turn clockwise to increase damping and counter clockwise to decrease it (fig.2).

Turn the damping adjusters clockwise to fully closed (centre position zero [0]). Then, turn counter clockwise to open, and count the clicks until you reach the recommended number of clicks.

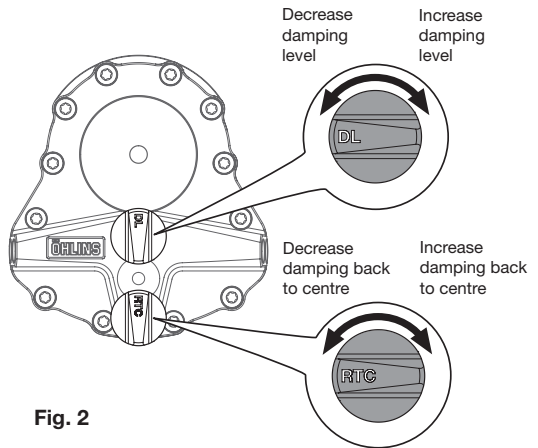

Fig. 2

Technical data

External measures (mounted on a bike)
97x88,5x50 mm

Seals of Low friction type

Pressurized reservoir

Öhlins Damper Fluid part no. 01303-01

Maximum steering angle $\pm 47^\circ$ (fig.4)

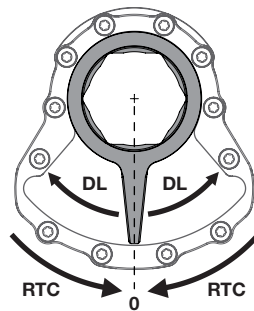

Fig. 3

Recommended basic settings

Motocross:

DL-valve: 12 clicks

RTC-valve: 6 clicks

Enduro:

DL-valve: 12 clicks

RTC-valve: 8 clicks

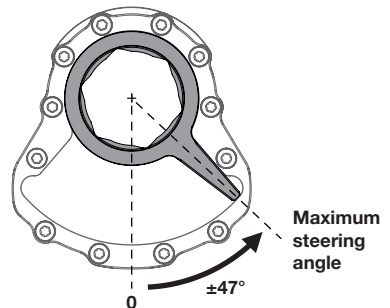

Fig. 4

Adjustments and Set-up

DL valve

With the standard setting (12 clicks) the damper will have a minimal amount of low speed damping and more or less only have damping from the high speed valve. This is very easy to get used to for someone that has not ridden with a steering damper before.

If more stability is required, try closing the DL valve one or two clicks at a time. We do not recommend going under 4 clicks. A rider who is used to riding with a steering damper can use more DL than someone who is not used to one.

RTC valve

When the RTC valve is completely closed the amount of damping back to center will be equal to the damping out from center (controlled by the DL valve). Fully open there is almost no damping at all back to center position.

An increase in RTC gives more stability into corners and makes it easier to hit the correct line. A rider who is used to riding with a steering damper can use more RTC than someone who is not used to one.

Rider type (general)

Very precise rider/ Not much steering correction
Aggressive rider/ A lot of steering corrections

Note! Just like a very precise rider, an aggressive rider can also benefit from an increase in RTC, but risk using up more energy because of the numerous steering corrections.

RTC (General)

Increase RTC
Decrease RTC

Track conditions

Fast tracks
Rutted tracks or deep sand
High speed head shake
Low speed head shake
Tight enduro trail
More stability into corners and to make it easier to hit the correct line
Desert racing

DL/RTC

Increase DL
Decrease DL and/or decrease RTC (often fully open)
Increase DL, possibly also increase RTC
Increase DL, keep RTC
Decrease RTC
Increase RTC, keep DL
Increase DL, increase RTC

See also adjusters in fig.2 on page 5

Troubleshooting and Maintenance

Trouble Shooting

- **There is little or no damping:**
Debris in valving or worn parts internally, need service.
- **The damper units is moving at the top of the triple clamp:**
Tighten the top nut for the steering stem with the tool provided in the kit.
- **The steering damper is out of position (which can happen after a crash):**
 - A. Check that the bracket (*that replaces the outer bearing*) is aligned properly. If not, tap it with an hammer into the correct position - see mounting instruction. Be careful so that the bracket not will be damaged.
 - B. Check that the damper still is in correct position. If not, reinstall it according to the mounting instruction. Also make sure that the two small pins that goes into the top triple clamp still are in place. If not, contact your Öhlins dealer.
- **Leakage occurs:**
Check that all bolts and nuts are tightened, or contact an Öhlins dealer.
- **The damper does not fit in between the handlebar and the triple clamp:**
 - C. Some bike has bolted handlebar clamps, those clamps can be raised up with spacers. Otherwise a new upper triple clamp may be needed.

Maintenance and inspection

The steering damper is a precision instrument, with extremely fine tolerances. It is therefore essential that it is maintained in a correct manner. Maintenance and service should be carried out by an authorised service centre.

After washing the motorcycle wipe clean and spray with all-round oil.

CAUTION!

Never subject to direct high-pressure cleaning since water may penetrate the damper.

CAUTION!

Ensure that there is no leakage of fluid and that there is no visible damage to the housing and mounts. Change the fluid regularly every 20 hours. Use only recommended fluid that is tested and approved by Öhlins. We cannot guarantee fully acceptable operation using other fluids.

NOTE!

Regular maintenance and inspection counteracts possible malfunction. If the steering damper needs service, contact an Öhlins dealer who have the proper tools and know-how to solve all technical problems.

NOTE!

Discarded Öhlins products should be handled over to an authorized work shop or distributor for proper disposal.

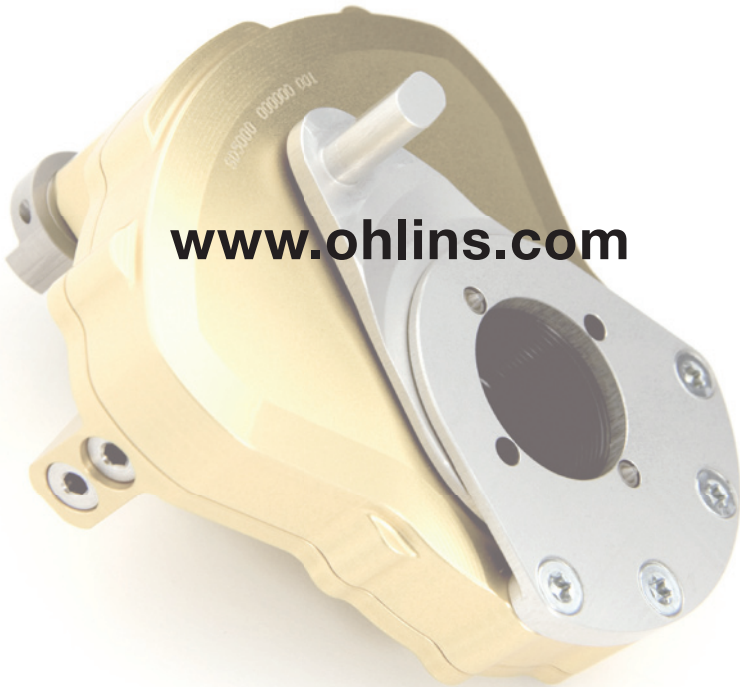

www.ohlins.com



Öhlins Racing AB Box 722
S 194 27 Upplands Väsby Sweden
Phone +46 8 590 025 00
Fax +46 8 590 025 80



ADVANCED SUSPENSION TECHNOLOGY